



Civil Engineers
Structural Engineers
Traffic Engineers
Land Surveyors
Landscape Architects
Scientists

Project # 47617.00

City of Portsmouth

***Wetlands Conditional Use
Permit Application***

for

Shawn & Michiyo Bardong

***For the Construction of a Two-Story Addition and
Related Site Improvements***

39 Dearborn Street, Portsmouth NH

Rockingham County

November 26, 2024

TFMoran, Inc.

170 Commerce Way – Suite #102
Portsmouth, NH 03801
(603) 431-2222



Civil Engineers
 Structural Engineers
 Traffic Engineers
 Land Surveyors
 Landscape Architects
 Scientists



City of Portsmouth Wetlands Conditional Use Permit Application

November 21, 2024

Samantha Collins, Chair, and Conservation Commission Members
 1 Junkins Ave
 Portsmouth, NH 03801

**Re: Wetlands Conditional Use Permit Application
 39 Dearborn Street, Portsmouth NH - Tax Map: 140 Lot: 3
 Project #47617.00**

Dear Ms. Collins,

On behalf of TFMoran Inc., a City of Portsmouth Wetlands Conditional Use Permit Application was filed on September 25th, 2024, for the above referenced property. The property owner's, Shawn & Michiyo Bardong, have proposed an expansion to their existing dwelling and other related site improvements. The proposed expansion is the construction of a two-story family room, a mudroom, and a sewer connection. Removal of the existing shed is required as the footprint of the proposed addition overlaps this area. Further, as per the meeting on October 9th, 2024, the board informed us that the existing driveway is in violation of the zoning ordinance. The previous property owner did not complete the required work permitted under the previous 2016 CUP permit. This permit required the driveway to be constructed of pervious materials.

To remedy this, we have revised our application to ensure the driveway is converted to a pervious surface. While this will require more impacts to the wetland buffer, it is beneficial to the long-term health of the resource, and to regain compliance with the zoning ordinance.

The subject lot is unique as it exists almost entirely (99.4% of the lot) within the 100' tidal wetland buffer area. Within the wetland buffer area, the vegetation consists primarily of grass lawn, with a few native plant species scattered around the edge of the property. When approaching the tidal resource, North Mill Pond, salt marsh and mud flat areas are observed, consisting primarily of salt tolerant grasses. Invasive species were not observed during the brief site visit as the lot is mostly developed.

As the property exists, excluding the driveway that *should be pervious*, 17.4% is paved/developed (1,945 Sq. Ft./11,166 S.F. * 100= 17.4% Impervious) within the 100' tidal wetland buffer. The proposed site improvements will result in only a subtle 2% increase in impervious lot coverage - 19.1% (2,138 S.F. / 11,166 S.F. * 100= 19.1% Impervious).

TFMoran, Inc.
 48 Constitution Drive, Bedford, NH 03110
 T(603) 472-4488 www.tfmoran.com



TFMoran, Inc. Seacoast Division
 170 Commerce Way-Suite 102, Portsmouth, NH 03801
 T(603) 431-2222



Civil Engineers
Structural Engineers
Traffic Engineers
Land Surveyors
Landscape Architects
Scientists



Addressing the Criteria for Approval outlined in section 10.1017.50:

(1) The land is reasonably suited to the use, activity or alteration.

The project site exists as a developed residential lot which is suitable for the proposed improvements. The proposed expansion can occur while also protecting the functions and values of the neighboring resource.

(2) There is no alternative location outside the wetland buffer that is feasible and reasonable for the proposed use, activity or alteration.

The lot exists almost entirely within the 100 ft tidal buffer zone. The proposed home addition is the furthest distance from the wetland resource.

(3) There will be no adverse impact on the wetland functional values of the site or surrounding properties.

No direct impacts are proposed to the wetland resource. Sound stormwater management techniques are proposed to ensure there will be no increases in stormwater discharge from the property. The surrounding properties will not be adversely affected by this project.

(4) Alteration of the natural vegetative state or managed woodland will occur only to the extent necessary to achieve construction goals; and

No alteration of the natural vegetative state is proposed. This project also proposes to increase the width of the natural vegetative buffer adjacent to the resource.

(5) The proposal is the alternative with the least adverse impact to areas and environments under the jurisdiction of this Section.

This project is the least impacting practical alternative. Environmentally beneficial techniques have been proposed.





Civil Engineers
Structural Engineers
Traffic Engineers
Land Surveyors
Landscape Architects
Scientists

**NEW
HAMPSHIRE
200**

(6) Any area within the vegetated buffer strip will be returned to a natural state to the extent feasible.

Impacted areas within the vegetated buffer strip will be reseeded with a native conservation seed mix. An area currently existing as lawn will be allowed to return to a natural state.

Sincerely,

TFMoran, Inc.

Luke Taylor,
Environmental Permitting Specialist

TFMoran, Inc.
48 Constitution Drive, Bedford, NH 03110
T(603) 472-4488 www.tfmoran.com



TFMoran, Inc. Seacoast Division
170 Commerce Way–Suite 102, Portsmouth, NH 03801
T(603) 431-2222



Civil Engineers
 Structural Engineers
 Traffic Engineers
 Land Surveyors
 Landscape Architects
 Scientists



City of Portsmouth Wetlands Conditional Use Permit Application

10.1017.20 Application Requirements

10.1017.21

The application shall be in a form prescribed by the Planning Board, and shall include the following information:

(1) Location and area of lot and proposed activities and uses;

Project lot at 39 Dearborn Street, Portsmouth, NH 03801. Tax map: 140, Lot 3.

Lot Area

Total: 11,236 Sq. Ft. (0.25 Acres)

Within 100' Tidal Buffer Zone: 11,166 Sq. Ft.

Proposed Activities

Impact 4,118 square feet of the Previously Developed Upland Tidal Buffer Zone for the purpose of constructing a 2-story addition and mudroom to the existing dwelling, converting a driveway to pervious turnstones, installing a sewer connection and incorporating a stormwater management feature.

(2) Location and area of all jurisdictional areas (vernal pool, inland wetland, tidal wetland, river or stream) on the lot and within 250 feet of the lot;

All protected resources are depicted on the *CUP Impact Plan*.

(3) Location and area of wetland buffers on the lot;

Wetland Buffer Areas

25' Wetland Setback: 2505 Sq. Ft.

50' Wetland Setback: 6,649 Sq. Ft.

100' Wetland Setback: 11,166 Sq. Ft.

All relevant setbacks/buffers are depicted on the *CUP Impact Plan*.





Civil Engineers
 Structural Engineers
 Traffic Engineers
 Land Surveyors
 Landscape Architects
 Scientists



(4) Description of proposed construction, demolition, fill, excavation, or any other alteration of the wetland or wetland buffer;

This project proposes demolition of an existing shed, construction of a 2-story addition and mudroom to the existing dwelling, converting a driveway to pervious turnstones, installing a sewer connection and constructing a new appropriately designed rain garden.

(5) Setbacks of proposed alterations from property lines, jurisdictional areas and wetland buffers;

Existing Building Setbacks

Front Yard: 27 Ft.
 Rear Yard: 2 Ft.
 Right Side Yard: 2.2 Ft.
 Left Side Yard: 114.8 Ft.

Proposed Building Setbacks

Front Yard: 5 Ft.
 Rear Yard: 2 Ft.
 Right Side Yard: 2.2 Ft.
 Left Side Yard: 114.8 Ft.

(6) Location and area of wetland impact, new impervious surface, previously disturbed upland;

No direct wetland impacts are proposed, only the currently developed wetland buffer will be impacted.

(7) Location and description of existing trees to be removed, other landscaping, grade changes, fill extensions, rip rap, culverts, utilities;

No tree removal, significant grade changes, fill extensions, rip rap or culverts are proposed. The only grade changes area occurring for the purpose of constructing the rain garden. Landscaping includes construction of a rain garden and erosion control buffer plantings. Utility work includes a new sewer connection that has already been installed.

(8) Dimensions and uses of existing and proposed buildings and structures.

See *Boundary Plan* and property card for existing building/structure dimensions.

See *Proposed Foundation Plan* and *Proposed First Floor Plan* for proposed building/structure dimensions.

(9) Any other information necessary to describe the proposed construction or alteration.





Civil Engineers
Structural Engineers
Traffic Engineers
Land Surveyors
Landscape Architects
Scientists



10.1017.22

Where the proposed project will involve the temporary or permanent alteration of more than 250 sq. ft. of wetland and/or wetland buffer, the application shall provide information about the affected wetland and wetland buffer as follows:

(3) More than 250 sq. ft. of alteration to the wetland buffer (regardless of the amount of alteration to the wetland): a description of the 100-foot buffer including vegetation type, the percent of the buffer with invasive species, and the percent of the buffer that is paved or developed.

The subject lot is unique as it exists almost entirely (99.4% of the lot) within the 100' tidal wetland buffer area. Within the wetland buffer area, the vegetation present consists primarily of grass lawn, with a few native plant species scattered around the edge of the property. When approaching the tidal resource, North Mill Pond, salt marsh and mud flat areas are observed, consisting primarily of salt tolerant grasses. Invasive species were not observed during the brief site visit as the lot is mostly developed.

See *CUP Impact Plan* for impervious surface numbers.

10.1017.24

Where feasible, the application shall include removal of impervious surfaces at least equal in area to the area of impervious surface impact. The intent of this provision is that the project will not result in a net loss of pervious surface within a jurisdictional wetland buffer. If it is not feasible to remove impervious surfaces from the wetland buffer at least equal in area to the area of new impervious surface impact, the application shall include a wetland buffer enhancement plan that describes how the wetland functions and values will be enhanced to offset the proposed impact.

While this project proposes to convert the existing driveway to a pervious material, we recognize this should have been completed under a previous approval. There is no other practical means of decreasing impervious area within the buffer.

The proposed increase in impervious area resulting from this project is only 193 Sq. Ft. To offset this increase, we are proposing to allow 2,505 square of area, currently existing as manicured lawn, to naturalize within the 25' wetland buffer. Also, we are proposing a 20' X 8' rain garden to assist in infiltrating stormwater. Finally, we're proposing additional planting to enhance the natural buffer, namely Seaside Goldenrod and Rose Mallow.

Through the incorporation of the proposed stormwater management techniques and the wetland buffer enhancement, this project will not result in any adverse impacts to the tidal resource and/ or its functions and values.

See *CUP Impact Plan* for details.





Civil Engineers
Structural Engineers
Traffic Engineers
Land Surveyors
Landscape Architects
Scientists



10.1017.25

A wetland buffer enhancement plan shall be designed to enhance the functions of the jurisdictional wetland and/or wetland buffer on the lot, and to offset the impact of the proposed project.

- (1) The wetland buffer enhancement plan shall include a combination of new plantings, invasive species removal, habitat creation areas, improved site hydrology, or protective easements provided offsite.
- (2) Where the vegetated buffer strip contains grass or non-native plantings, or is otherwise not intact, the first priority of the wetland buffer enhancement plan shall be to include revegetation of the vegetated buffer strip with native, low-maintenance shrubs and other woody vegetation.

See *CUP Impact Plan* for erosion control buffer plantings, and no-mow area.

10.1017.26

Where the proposed project involves a use, activity or alteration in a tidal wetland or tidal wetland buffer, the application shall include a living shoreline strategy to preserve the existing natural shoreline and/or encourage establishment of a living shoreline through restoration, as applicable. Said living shoreline strategy shall be implemented unless the Planning Board determines that it is not feasible.

The entire 25' wetland setback on the lot, will be allowed to naturalize completely and salt tolerant native plants will be introduced. As it exists today, the 25' wetland setback is mowed grass lawn, this project proposes to allow the buffer to naturalize into a more robust, effective buffer.

10.1018.10 Stormwater Management

All construction activities and uses of buildings, structures, and land within wetlands and wetland buffers shall be carried out so as to minimize the volume and rate of stormwater runoff, the amount of erosion, and the export of sediment from the site. All such activities shall be conducted in accordance with Best Management Practices for stormwater management including but not limited to:

1. New Hampshire Stormwater Manual, NHDES, current version.
2. Best Management Practices to Control Non-point Source Pollution: A Guide for Citizens and City Officials, NHDES, January 2004

All activities shall be conducted in accordance with Best Management Practices for stormwater management. Proper erosion and sedimentation control will be installed prior to start of construction and will not be removed until after construction activities are completed. Further, all construction equipment will be inspected daily for leaks, and oil-spill kits will be present on site for the duration of construction.





Civil Engineers
Structural Engineers
Traffic Engineers
Land Surveyors
Landscape Architects
Scientists

**NEW
HAMPSHIRE
200**

Section 10.1018.30 Porous Pavement in Wetland Buffer

10.1018.32

An application that proposes porous pavement in a wetland buffer shall include a pavement maintenance plan addressing erosion control, periodic removal of sediment and debris from the porous surfaces, snow management, and repairs.

See attached *Details* sheet for maintenance notes.

10.1018.40 Wetland Boundary Markers

Permanent wetland boundary markers shall be shown on the plan submitted with an application for a conditional use permit and shall be installed during project construction.

Please see *CUP Impact Plan* for wetland boundaries. Wetland boundary markers will be installed during project construction.

TFMoran, Inc.
48 Constitution Drive, Bedford, NH 03110
T(603) 472-4488 www.tfmoran.com



TFMoran, Inc. Seacoast Division
170 Commerce Way–Suite 102, Portsmouth, NH 03801
T(603) 431-2222

39 DEARBORN ST

Location 39 DEARBORN ST

Mblu 0140/ 0003/ 0000/ /

Acct# 34219

Owner BARDONG SHAWN & MICHIO

PBN

Assessment \$660,300

Appraisal \$660,300

PID 34219

Building Count 1

Current Value

Appraisal			
Valuation Year	Improvements	Land	Total
2023	\$258,100	\$402,200	\$660,300

Assessment			
Valuation Year	Improvements	Land	Total
2023	\$258,100	\$402,200	\$660,300

Owner of Record

Owner BARDONG SHAWN & MICHIO

Sale Price \$1,200,000

Co-Owner

Certificate

Address 39 DEARBORN ST

Book & Page 6450/552

PORTSMOUTH, NH 03801

Sale Date 11/02/2022

Instrument 00

Ownership History

Ownership History					
Owner	Sale Price	Certificate	Book & Page	Instrument	Sale Date
BARDONG SHAWN & MICHIO	\$1,200,000		6450/552	00	11/02/2022
BRANDZEL MICHAEL	\$330,000		5000/1302	33	04/15/2009

Building Information

Building 1 : Section 1

Year Built: 1700
Living Area: 1,080
Replacement Cost: \$227,387

Building Percent Good: 79

Replacement Cost

Less Depreciation: \$179,600

Building Attributes

Field	Description
Style:	Antique
Model	Residential
Grade:	C+
Stories:	1
Occupancy	1
Exterior Wall 1	Vinyl Siding
Exterior Wall 2	
Roof Structure:	Gable/Hip
Roof Cover	Asph/F Gls/Cmp
Interior Wall 1	Plastered
Interior Wall 2	Drywall/Sheet
Interior Flr 1	Pine/Soft Wood
Interior Flr 2	
Heat Fuel	Gas
Heat Type:	Hot Air-no Duc
AC Type:	Heat Pump
Total Bedrooms:	3 Bedrooms
Total Bthrms:	1
Total Half Baths:	0
Total Xtra Fixtrs:	1
Total Rooms:	6
Bath Style:	Avg Quality
Kitchen Style:	Good Quality
Kitchen Gr	
WB Fireplaces	1
Extra Openings	0
Metal Fireplaces	0
Extra Openings 2	0
Bsmt Garage	0

Building Photo



(<https://images.vgsi.com/photos2/PortsmouthNHPhotos/\00\02\21\46.jpg>)

Building Layout

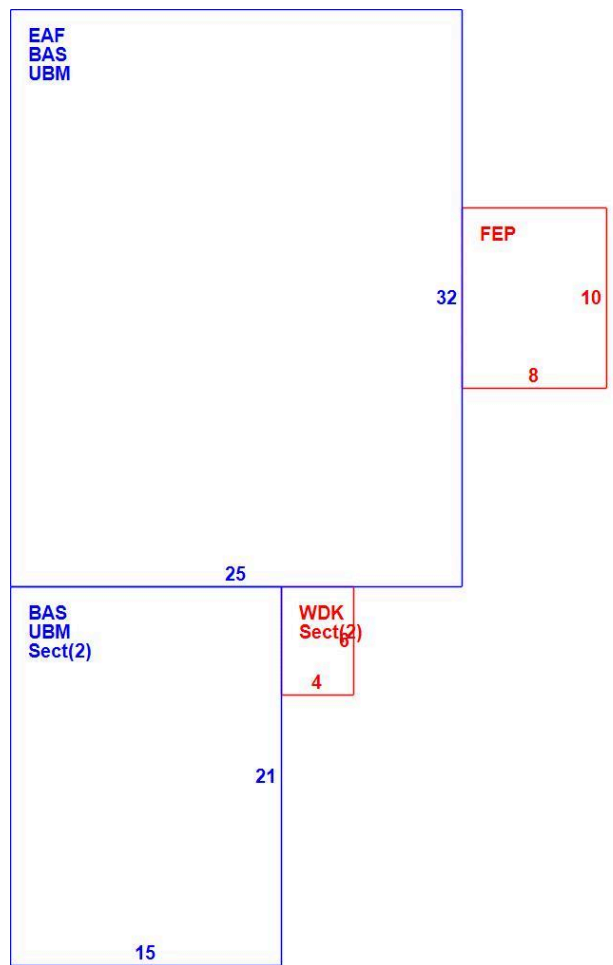

(ParcelSketch.ashx?pid=34219&bid=34219)

Building Sub-Areas (sq ft)			Legend
Code	Description	Gross Area	Living Area
BAS	First Floor	800	800
EAF	Attic Expansion	800	280
FEP	Porch, Enclosed	80	0
UBM	Basement, Unfinished	800	0

Building 1 : Section 2

Year Built: 2016
Living Area: 315
Replacement Cost: \$76,515
Building Percent Good: 97
Replacement Cost Less Depreciation: \$74,200

Building Attributes : Section 2 of 2

Field	Description
Style:	Antique
Model	Residential
Grade:	C+
Stories:	1
Occupancy	1
Exterior Wall 1	Wood Shingle
Exterior Wall 2	
Roof Structure:	Gable/Hip
Roof Cover	Asph/F GlS/Cmp
Interior Wall 1	Drywall/Sheet
Interior Wall 2	
Interior Flr 1	Pine/Soft Wood
Interior Flr 2	
Heat Fuel	Gas
Heat Type:	Hot Air-no Duc
AC Type:	Heat Pump
Total Bedrooms:	3 Bedrooms
Total Bthrms:	1
Total Half Baths:	0
Total Xtra Fixtrs:	1
Total Rooms:	6
Bath Style:	Avg Quality
Kitchen Style:	Good Quality
Kitchen Gr	
WB Fireplaces	1
Extra Openings	0
Metal Fireplaces	0
Extra Openings 2	0
Bsmt Garage	0

Building Photo

(<https://images.vgsi.com/photos2/PortsmouthNHPhotos//default.jpg>)

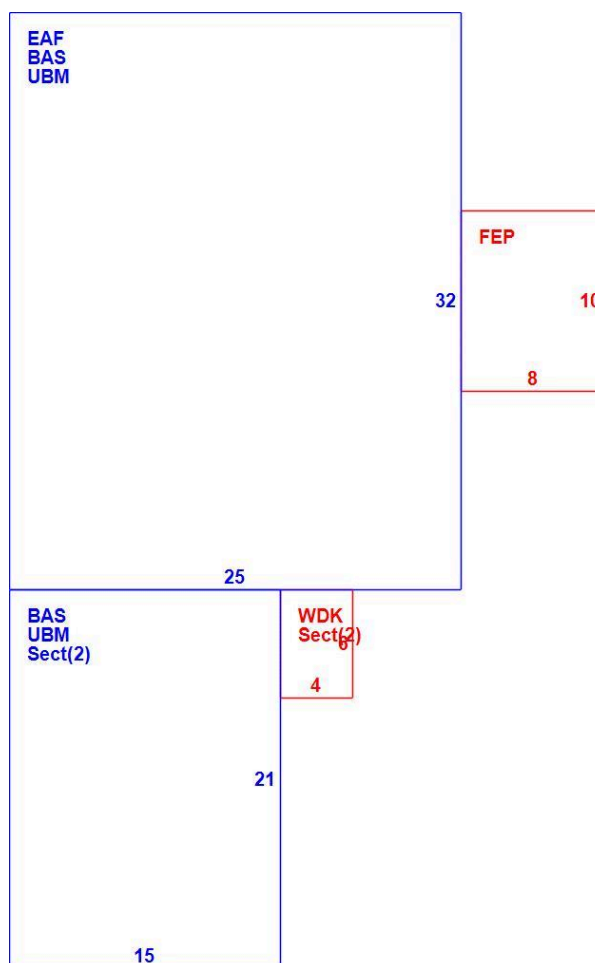
Building Layout

(ParcelSketch.ashx?pid=34219&bid=34219)

Building Sub-Areas (sq ft)			Legend
Code	Description	Gross Area	Living Area

BAS	First Floor	315	315
UBM	Basement, Unfinished	315	0
WDK	Deck, Wood	24	0
		654	315

Extra Features

Extra Features	<u>Legend</u>
No Data for Extra Features	

Land

Land Use

Use Code	1013
Description	SFR WATERFRONT
Zone	GRA
Neighborhood	131
Alt Land Appr Category	No

Land Line Valuation

Size (Acres)	0.26
Frontage	
Depth	
Assessed Value	\$402,200
Appraised Value	\$402,200

Outbuildings

Outbuildings						<u>Legend</u>
Code	Description	Sub Code	Sub Description	Size	Value	Bldg #
SHD2	W/LIGHTS ETC			216.00 S.F.	\$4,300	1

Valuation History

Appraisal			
Valuation Year	Improvements	Land	Total
2023	\$258,100	\$402,200	\$660,300
2022	\$239,900	\$402,200	\$642,100
2021	\$239,900	\$402,200	\$642,100

Assessment			
Valuation Year	Improvements	Land	Total
2023	\$258,100	\$402,200	\$660,300
2022	\$239,900	\$402,200	\$642,100
2021	\$239,900	\$402,200	\$642,100

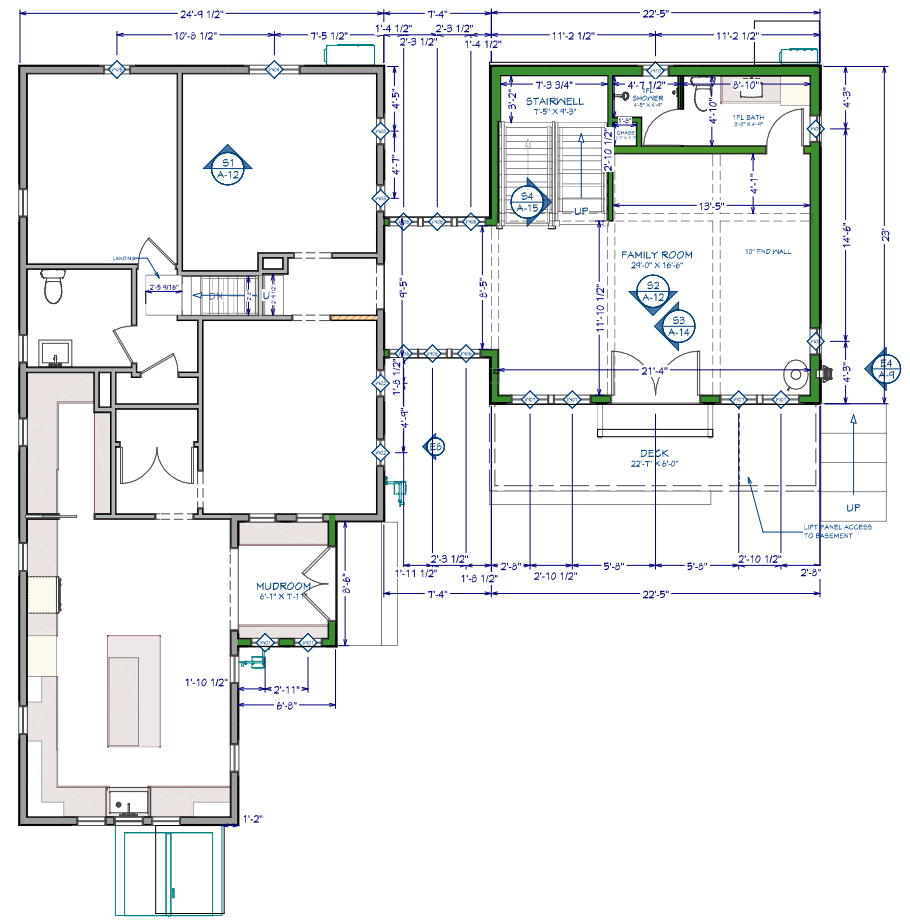
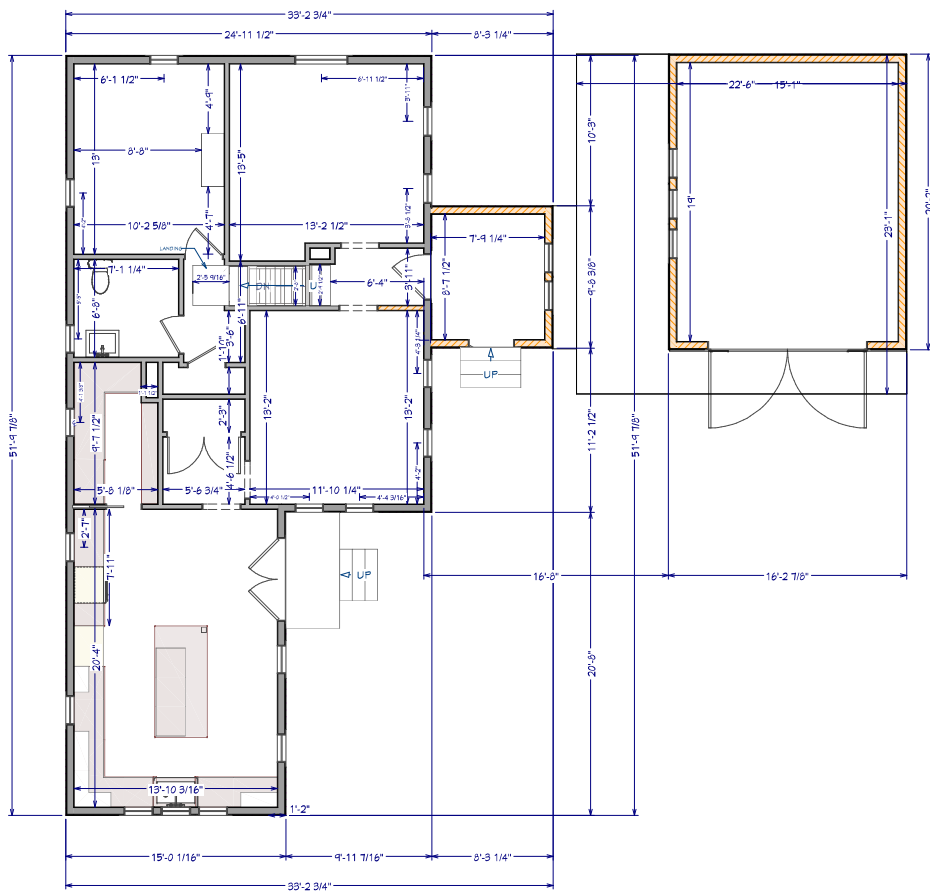

PROPOSED FIRST FLOOR PLAN
SCALE: 1/4" = 1'-0"

WALL LEGEND	
	= EXTERIOR WALL
	= INTERIOR 6
	= INTERIOR 4
	= NEW WALL
	= DEMO WALL
	= GLASS TOP TILE BOTTOM PONY WALL
	= GLASS SHOWER WALL



Number	Date	Description

FIRST FLOOR

CLIENT:
BARROWS
51 DEARBORN EXT
PORTSMOUTH, NH

CONTACT:
AMY DUTTON HOME
51 WALKER STREET KITTERY, ME
am@amyduttonhome.com
207.357.7220

DATE:
6/4/2024

COPYRIGHT © ASRSO HOME 2022

SCALED FOR:
24" X 36"

SCALE:
SEE SCALE ON DRAWINGS

SHEET:

Nov 25, 2024 - 12:30pm
F:\MISC Projects\47617\Dearborn St, Portsmouth, NH\47617-00 Dockham Builders 36 Dearborn St Portsmouth NH\Design\PRODUCTION DRWGS\47617-00-Impact-Plan.dwg

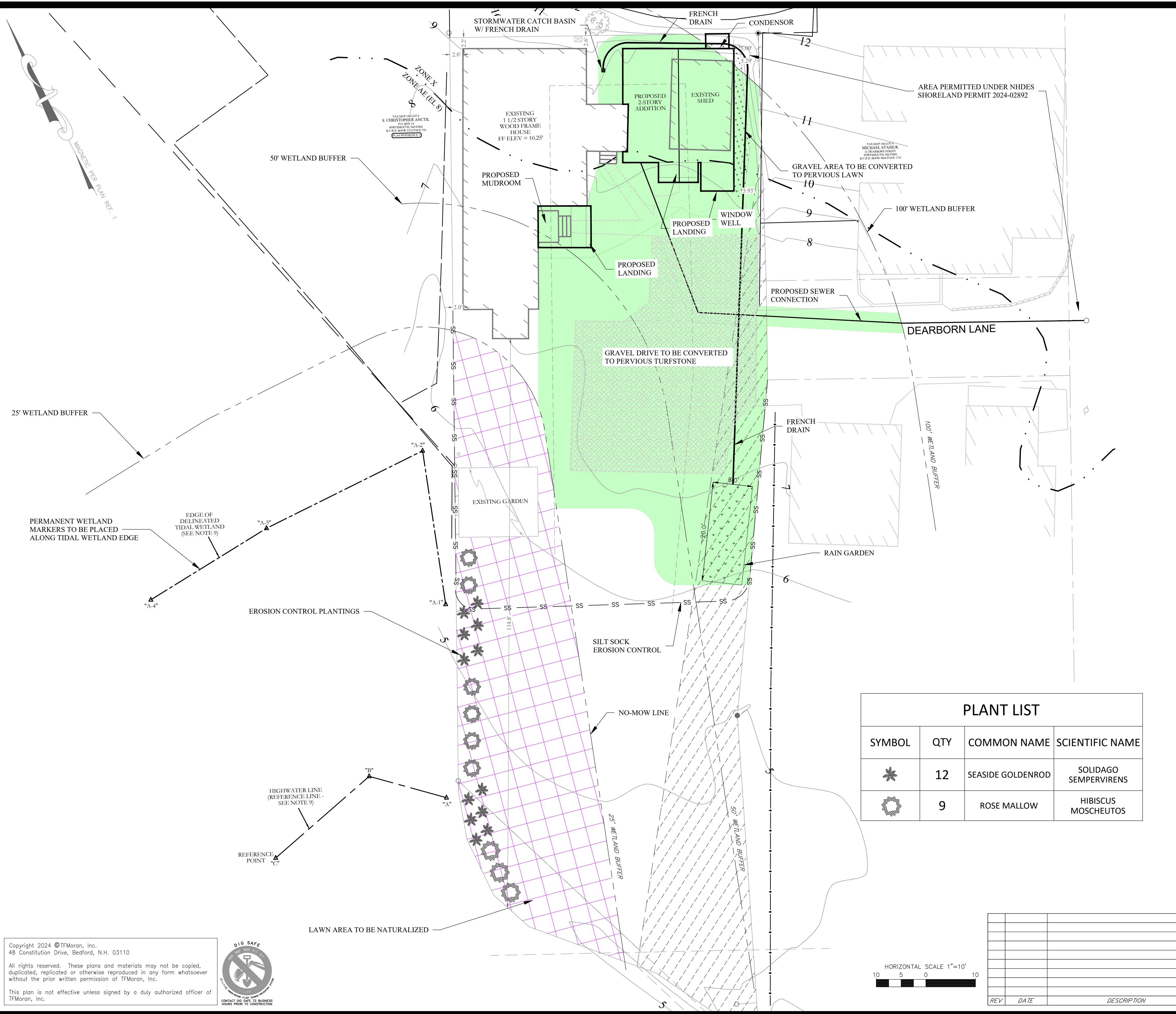

SITE DATA

OWNER OF RECORD OF MAP 140 LOT 3: SHAWN & MICHIO BARDONG
DEED REFERENCE TO PARCEL IS BK 6450 PG 552.
AREA OF PARCEL = 11,236± SF OR 0.25± ACRES

ZONED: GENERAL RESIDENCE A (GRA)
EXISTING USE: SINGLE FAMILY RESIDENTIAL
PROPOSED USE: SINGLE FAMILY RESIDENTIAL

THE PURPOSE OF THIS PLAN IS TO DEPICT THE IMPACTS ASSOCIATED WITH THE PROPOSED TWO-STORY DWELLING ADDITION, MUDROOM AREA AND SEWER CONNECTION.

NOTES

- GRAVEL DRIVEWAY TO BE CONVERTED TO PERVIOUS TURFSTONE PAVERS (SEE DETAIL) PER PREVIOUS PORTSMOUTH CONDITIONAL USE PERMIT APPROVAL.
- RAIN GARDEN HAS BEEN DESIGNED TO INFILTRATE STORMWATER FROM 500 S.F. OF RUNOFF SURFACES. SIZE AND CALCULATIONS ARE BASED ON "NEW HAMPSHIRE HOMEOWNER'S GUIDE TO STORMWATER MANAGEMENT".
- RAIN GARDEN PLANTINGS WILL BE CHOSEN FROM "NATIVE PLANTS FOR NEW ENGLAND RAIN GARDENS" AND RECOMMENDATIONS FROM THE CONSERVATION COMMISSION.
- ALL ACTIVITIES WITHIN WETLANDS AND WETLAND BUFFERS SHALL BE CONDUCTED IN ACCORDANCE WITH BEST MANAGEMENT PRACTICES FOR STORMWATER MANAGEMENT.
- PERMANENT WETLAND BOUNDARY MARKERS SHALL BE INSTALLED DURING PROJECT CONSTRUCTION

LEGEND

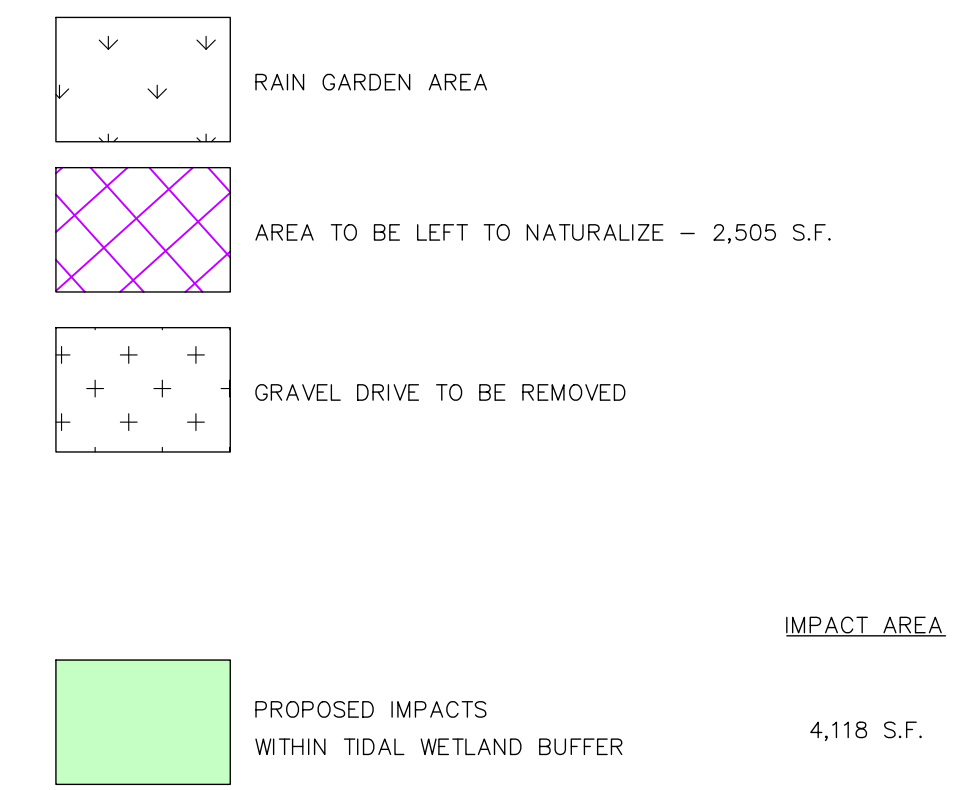

PRE-CONSTRUCTION IMPERVIOUS AREA WITHIN 100' OF REFERENCE LINE		POST-CONSTRUCTION IMPERVIOUS AREA WITHIN 100' OF REFERENCE LINE	
PRIMARY STRUCTURE	1,233 S.F.	PRIMARY STRUCTURE	1,802 S.F.
SHED	222 S.F.	SHED	0 S.F.
MUDROOM AND LANDING	36 S.F.	MUDROOM AND LANDING	91 S.F.
GRAVEL WALKWAY AREAS	454 S.F.	GRAVEL WALKWAY AREAS	245 S.F.
TOTAL	1,945 S.F.	TOTAL	2,138 S.F.
IMPERVIOUS COVERAGE WITHIN 100' OF REFERENCE LINE = 17.4% (1,945 S.F. / 11,166 S.F. * 100%)		IMPERVIOUS COVERAGE WITHIN 100' OF REFERENCE LINE = 19.1% (2,138 S.F. / 11,166 S.F. * 100%)	

PLANT LIST

SYMBOL	QTY	COMMON NAME	SCIENTIFIC NAME
✿	12	SEASIDE GOLDENROD	SOLIDAGO SEMPERVIRENS
⊗	9	ROSE MALLOW	HIBISCUS MOSCHEUTOS

SITE DEVELOPMENT PLANS

TAX MAP 140 LOT 3
CONDITIONAL USE PERMIT IMPACT PLAN
BARDONG RESIDENCE
39 DEARBORN STREET, PORTSMOUTH NH
OWNED BY
SHAWN & MICHIO BARDONG
PREPARED FOR
DOCKHAM BUILDERS, LLC
1"=20' (11"X17")
SCALE: 1"=10' (22"X34') **SEPTEMBER 16, 2024**

Copyright 2024 ©TFMoran, Inc.
48 Constitution Drive, Bedford, N.H. 03110
All rights reserved. These plans and materials may not be copied, duplicated, replicated or otherwise reproduced in any form whatsoever without the prior written permission of TFMoran, Inc.
This plan is not effective unless signed by a duly authorized officer of TFMoran, Inc.

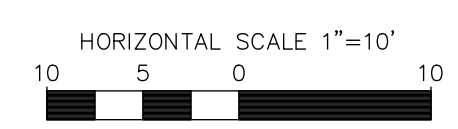

REV	DATE	DESCRIPTION	DR	CK

TFM	Civil Engineers	48 Constitution Drive Bedford, NH 03110 Phone (603) 472-4488 Fax (603) 472-9747 www.tfmoran.com	
	Structural Engineers Traffic Engineers Land Surveyors Landscape Architects Scientists		
FILE: 47617.00	DR: LST CK: JRA	FB: - CADFILE: CUP-IMPACT-PLAN	C-01

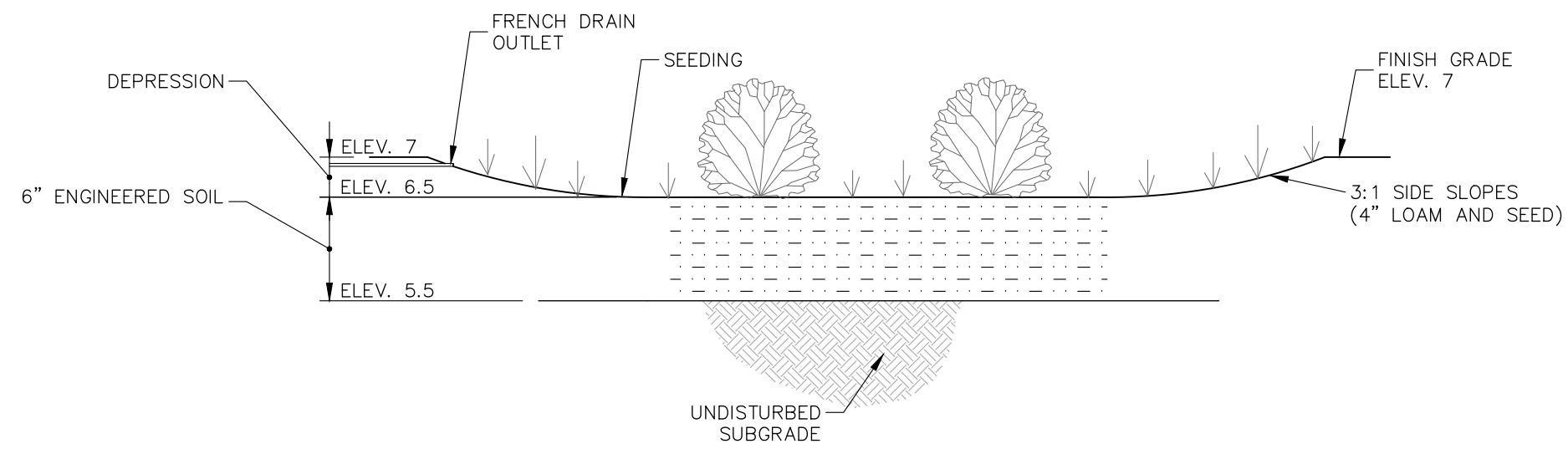

RAIN GARDEN DETAIL

NOT TO SCALE

SEEDING

- USE NEW ENGLAND EROSION CONTROL/RESTORATION MIX FOR MOIST SITES BY NEW ENGLAND WETLAND PLANTS, INC. OR EQUIVALENT.
- SEED AT A RATE OF 1LB/1250SF. APPLY TO BARE SOIL. LIGHTLY MULCH WITH CLEAN WEED FREE STRAW.

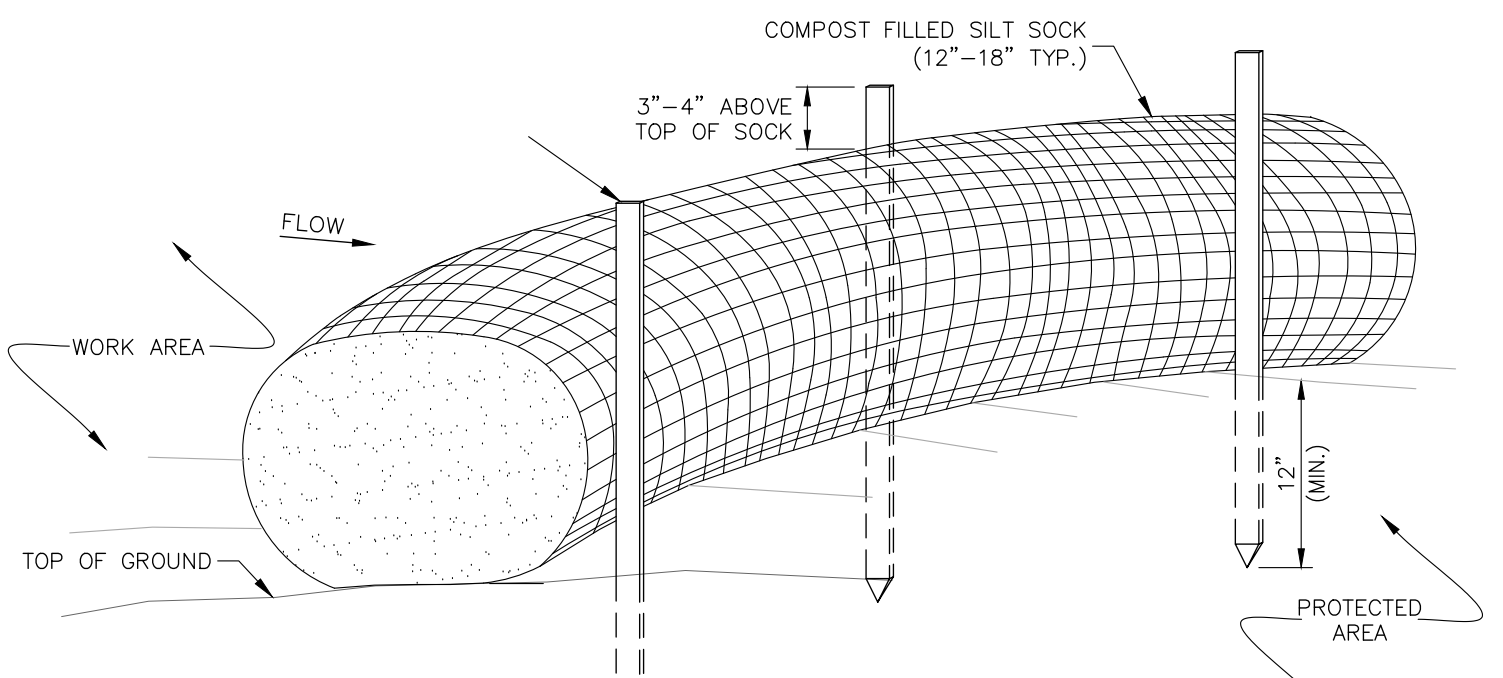

NOTES

- SILT SOCK SHALL BE FILTREXXTM SILTSOXTM OR APPROVED EQUIVALENT.
- SEE SPECIFICATIONS FOR SOCK SIZE AND COMPOST FILL REQUIREMENTS.
- SILT SOCK SHALL BE INSPECTED PERIODICALLY AND AFTER ALL STORM EVENTS, AND REPAIR OR REPLACEMENT SHALL BE PERFORMED AS NEEDED.
- COMPOST MATERIAL SHALL BE DISPERSED ON SITE, AS DETERMINED BY THE ENGINEER.

SILT SOCK

NOT TO SCALE

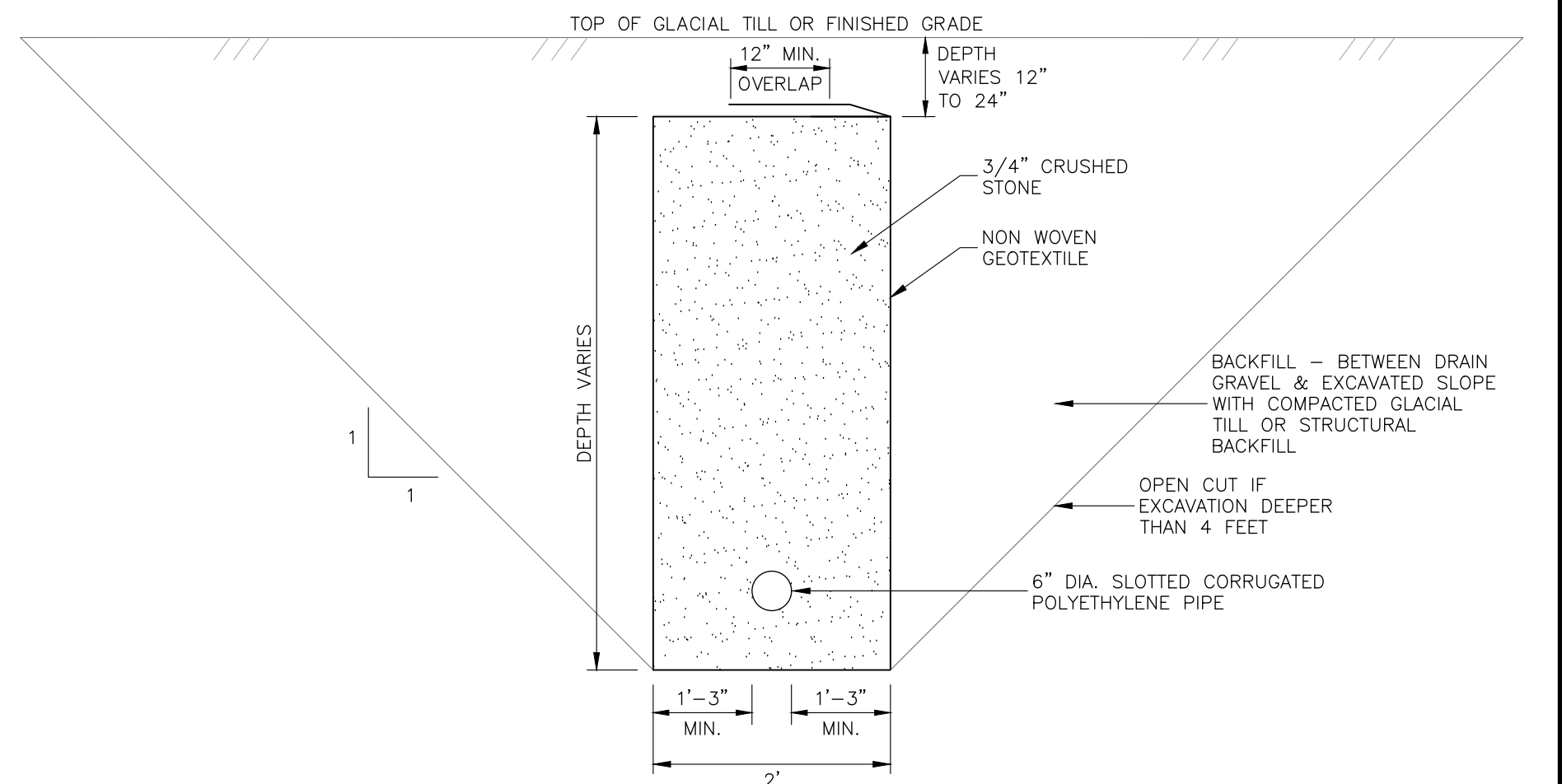

PERIMETER FRENCH DRAIN

DESIGN BY ENVIRONMENTAL COMPLIANCE SERVICES, INC.

NOT TO SCALE

RAIN GARDEN CONSTRUCTION

- CLEAR AND GRUB THE AREA WHERE THE RAIN GARDEN AREAS ARE TO BE LOCATED. STOCKPILE LOAM FOR REUSE ON SLOPES.
- GRADE RAIN GARDEN AREAS ACCORDING TO PLAN AND DETAILS. SIDE SLOPES SHALL HAVE 4" LOAM AND SEED AND A SLOPE NOT TO EXCEED 3:1. BOTTOM OF RAIN GARDEN AREAS TO BE CONSTRUCTED WITH MANUFACTURED SOIL (SEE RAIN GARDEN CONSTRUCTION DETAIL). SPECIFIC PLANTINGS SHALL BE PLACED IN THE FACILITY ACCORDING TO THE LANDSCAPE PLAN PLANTING DETAIL.
- RAIN GARDEN SOIL MIXTURE SHALL BE A UNIFORM MIX, FREE OF STONES, STUMPS, ROOTS OR OTHER SIMILAR OBJECTS LARGER THAN TWO INCHES EXCLUDING MULCH. NO OTHER MATERIALS OR SUBSTANCES SHALL BE MIXED OR DUMPED WITHIN THE RAIN GARDEN AREA THAT MAY BE HARMFUL TO PLANT GROWTH, OR PROVIDE A HINDRANCE TO THE PLANTING OR MAINTENANCE OPERATION.
- THE USDA TEXTURAL CLASSIFICATION OF THE SANDY SOIL SHALL BE LOAMY SAND OR SANDY LOAM.
- THE ENGINEERED SOIL - SEE ENGINEERED SOIL MIX NOTES.
 - SOILS TO BE TESTED AND APPROVED BY THE ENGINEER OF RECORD. ENGINEER SHALL SUBMIT LETTER OF VERIFICATION TO THE TOWN.
- THE CONTRACTOR SHALL TAKE MEASURES TO PREVENT EQUIPMENT & VEHICLE TRAFFIC FROM DRIVING IN THE AREA OF THE PROPOSED RAIN GARDEN AREA DURING CONSTRUCTION.
- AFTER THE BASIN IS EXCAVATED TO THE FINAL DESIGN ELEVATION, THE FLOOR SHOULD BE DEEPLY TILLED WITH A ROTARY TILLER OR DISC HARROW TO RESTORE INFILTRATION RATES. THE BASIN BOTTOM SHOULD BE LEVELED PRIOR TO BACKFILLING WITH CRUSHED STONE AND RAIN GARDEN SOIL MIXTURE.
- AASHTO #57 STONE CAN BE USED IN PLACE OF 3/4" CRUSHED STONE.

ENGINEERED SOIL MIX

- THE ENGINEERED SOIL IS MADE OF IS 10% WOOD CHIPS, 35% LOAM, AND 55% SAND.
- LOAM SHALL MEET THE USDA TEXTURAL CLASSIFICATION OF LOAMY FINE SAND.
- SAND SHALL BE CONCRETE SAND MEETING ASTM C-33 SPECIFICATION.
- WOOD CHIPS SHALL BE SHREDDED WOOD, WOOD CHIPS, GROUND BARK, OR WOOD WASTE, OF UNIFORM TEXTURE AND FREE OF STONES, STICKS, SOIL, OR TOXIC MATERIALS.
- SOIL REACTION: PH OF 6 TO 7.
- CEC OF TOTAL SOIL: MINIMUM 10 MEQ/100 ML AT PH OF 7.0.
- BASIS-OF-DESIGN PRODUCT: SUBJECT TO COMPLIANCE WITH REQUIREMENTS INDICATED ON DRAWINGS.
- BASIC PROPERTIES: MANUFACTURED SOIL SHALL NOT CONTAIN THE FOLLOWING:
 - UNACCEPTABLE MATERIALS: CONCRETE SLURRY, CONCRETE LAYERS OR CHUNKS, CEMENT, PLASTER, BUILDING DEBRIS, ASPHALT, BRICKS, OILS, GASOLINE, DIESEL FUEL, PAINT THINNER, TURPENTINE, TAR, ROOFING COMPOUND, ACID, SOLID WASTE, AND OTHER EXTRANEIOUS MATERIALS THAT ARE HARMFUL TO PLANT GROWTH.
 - UNSUITABLE MATERIALS: STONES, ROOTS, PLANTS, SOD, CLAY LUMPS, AND POCKETS OF COARSE SAND THAT EXCEED A COMBINED MAXIMUM OF 5 PERCENT BY DRY WEIGHT OF THE MANUFACTURED SOIL.
 - LARGE MATERIALS: STONES, CLODS, ROOTS, CLAY LUMPS, AND POCKETS OF COARSE SAND EXCEEDING 0.187 INCHES (4.76 MM) IN ANY DIMENSION.

RAIN GARDEN MAINTENANCE

MAINTENANCE SCHEDULE TO BEGIN AFTER CONSTRUCTION IS FINISHED AND BASIN STABILIZATION IS COMPLETE.

- CONTRACTOR AND LAND OWNERS TO PERFORM SCHEDULED MAINTENANCE ON THE RAIN GARDENS.
- REGULAR WATERING DURING THE FIRST FEW WEEKS AFTER PLANTING AND DURING HOT, DRY SPELLS, ESPECIALLY IN THE FIRST TWO YEARS AFTER PLANTING. AFTER THE FIRST TWO YEARS AND ONCE PLANTS ARE ESTABLISHED, WATERING SHOULD ONLY BE NECESSARY DURING DROUGHT CONDITIONS.
- FOR THE FIRST YEAR, FREQUENT AND AGGRESSIVE WEEDING MONTHLY DURING GROWING SEASON. REMOVE ONLY INVASIVE SPECIES.
- TWICE PER YEAR, INSPECT SPILLWAYS AND REMOVE ANY ACCUMULATED DEBRIS OR SEDIMENT TO ENSURE PROPER FUNCTIONALITY.
- ONCE A YEAR TRIM AND PRUNE EXCESS VEGETATION. DEAD, DYING, DISEASED, OR HAZARDOUS BRANCHES SHOULD BE TRIMMED AND REMOVED AS THEY OCCUR.
- DURING INSPECTIONS, REMOVE ANY TRASH, ACCUMULATED DEBRIS OR SEDIMENT.
- ONCE A YEAR INSPECT BERM FOR SETTLING. ADD COMPACTED SOIL AND REPLANT AS NEEDED.
- ONCE A YEAR IN THE FALL THE SYSTEM SHOULD BE INSPECTED FOR DRAWDOWN TIME AFTER A RAINFALL EVENT THAT EXCEEDS 1.0 INCHES IN A 24-HOUR PERIOD. THE SYSTEM SHOULD BE CHECKED TO CONFIRM THAT IT COMPLETELY DRAINS IN 72-HOUR AFTER THE RAINFALL EVENT. IF THE GARDEN DOES NOT DRAIN, A QUALIFIED PROFESSIONAL SHOULD ASSESS THE CONDITION OF THE FACILITY TO DETERMINE MEASURES REQUIRED TO RESTORE FILTRATION OR INFILTRATION FUNCTIONS, INCLUDING BUT NOT LIMITED TO REMOVAL OF ACCUMULATED SEDIMENTS.
- ONCE A YEAR TEST PLANTING BED FOR PH. IF THE PH IS BELOW 5.2, LIMESTONE SHOULD BE APPLIED. IF THE PH IS ABOVE 8.0, IRON SULFATE AND SULFUR SHOULD BE APPLIED.

ENGINEERED SOIL MIX PARTICLE SIZE DISTRIBUTION (PSD)			
PSD UPPER LIMIT		PSD LOWER LIMIT	
SIEVE #	% Passing	SIEVE #	% PASSING
4	100	4	100
10	95	10	95
40	40	40	15
200	20	200	15
<200	5	<200	5

RAIN GARDEN INSPECTION SCHEDULE

- RAIN GARDEN TO BE INSPECTED BY THE DESIGN ENGINEER FOR EACH STAGE OF CONSTRUCTION.
- PHASES OF CONSTRUCTION BEING:
 - EXCAVATION OF THE RAIN GARDEN BASIN, INCLUDING ROTOTILLING.
 - INSTALLATION OF THE CRUSHED STONE.
 - INSTALLATION OF THE ENGINEERED SOIL.
 - INSTALLATION OF THE OUTLET STRUCTURE AND UNDERDRAIN IN THE OUTLET STONE TRENCHES.
- SAMPLE OF THE INDIVIDUAL COMPONENTS OF THE ENGINEERED SOIL TO BE PROVIDED AND APPROVED PRIOR BEING COMBINED AND INSTALLED. SAMPLE CRUSHED STONE TO BE PROVIDED AND APPROVED PRIOR TO INSTALLATION.
- ENGINEER TO VERIFY MIX RATIO OF ENGINEERED SOIL MIX.

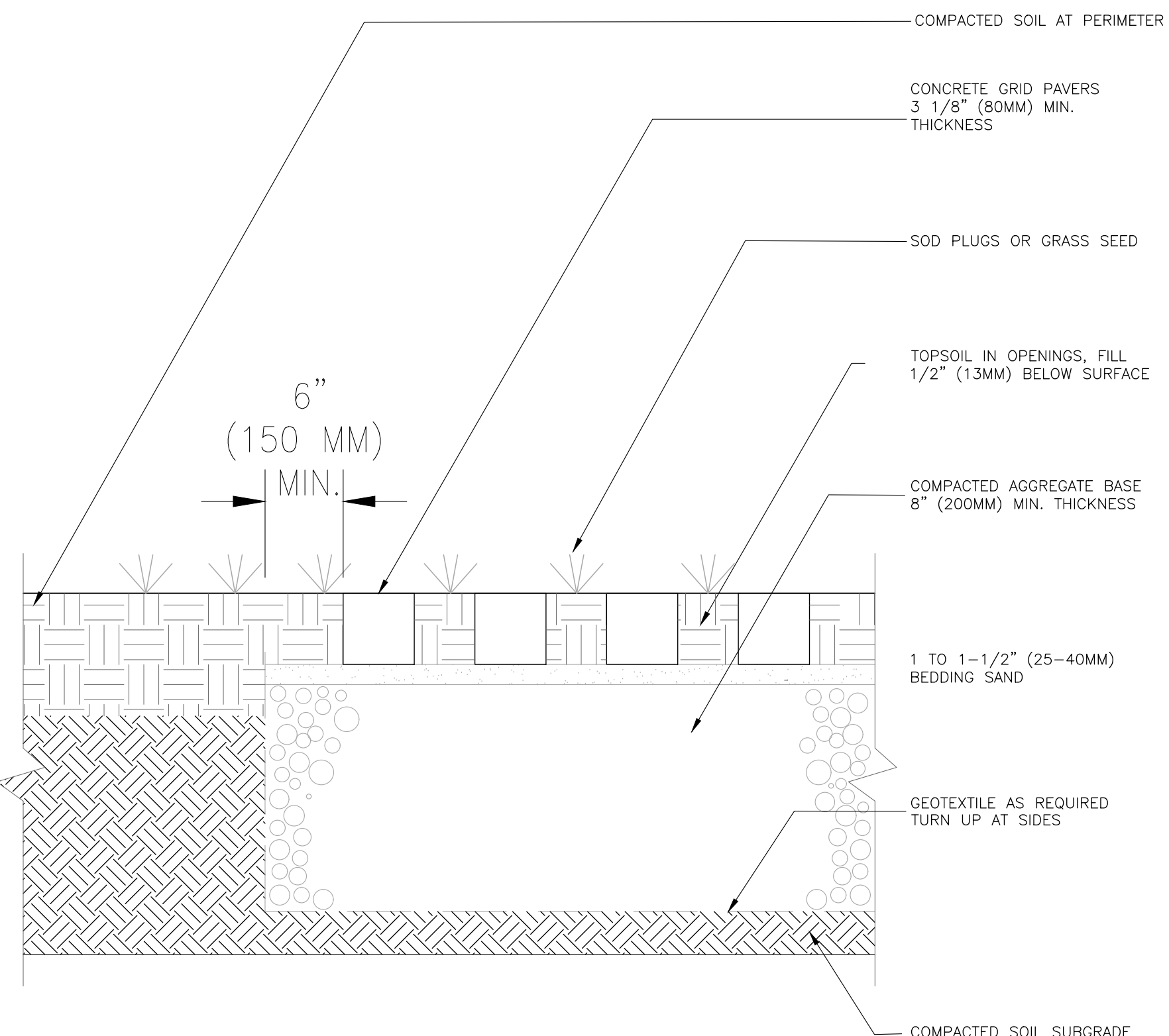

PERVIOUS TURFSTONE PAVERS

NOT TO SCALE

MAINTENANCE NOTES:

- NO WINTER SANDING OF PERMEABLE PAVEMENTS IS PERMITTED. MINIMIZE APPLICATION OF SALT FOR ICE CONTROL.
- INSPECT ANNUALLY FOR PAVEMENT DETERIORATION OR SPALLING.
- MONITOR PERIODICALLY TO ENSURE THAT THE PAVERS DRAINS EFFECTIVELY AFTER STORMS.
- PERIODICALLY ADD JOINT MATERIAL TO REPLACE LOST MATERIAL.
- MAJOR CLOGGING MAY NECESSITATE REPLACEMENT OF POROUS PAVERS AND POSSIBLY FILTER COURSE AND SUB-BASE COURSE.

REV	DATE	DESCRIPTION	DR	CK

Nov 25, 2024 - 12:35pm F:\MISC Projects\17617 Dearborn St, Portsmouth, NH\7617-00 Dockham Builders 36 Dearborn St, Portsmouth, NH\Design\PRODUCTION DRWG\47617.00-Impact-Plan.dwg

Copyright 2024 ©TFMoran, Inc.
48 Constitution Drive, Bedford, N.H. 03110
All rights reserved. These plans and materials may not be copied, duplicated, replicated or otherwise reproduced in any form whatsoever without the prior written permission of TFMoran, Inc.
This plan is not effective unless signed by a duly authorized officer of TFMoran, Inc.



SITE DEVELOPMENT PLANS

TAX MAP 140 LOT 3
DETAILS
BARDONG RESIDENCE
39 DEARBORN STREET, PORTSMOUTH NH
OWNED BY
SHAWN & MICHIO BARDONG
PREPARED FOR
DOCKHAM BUILDERS, LLC

SCALE: NTS **SEPTEMBER 16, 2024**

Civil Engineers
Structural Engineers
Traffic Engineers
Land Surveyors
Landscape Architects
Scientists

48 Constitution Drive
Bedford, NH 03110
Phone (603) 472-4488
Fax (603) 472-9747
www.tfmoran.com

FILE#	47617.00	DR	LST	FB	-
CK	JRA	CADFILE	CUP-IMPACT-PLAN		

C-03

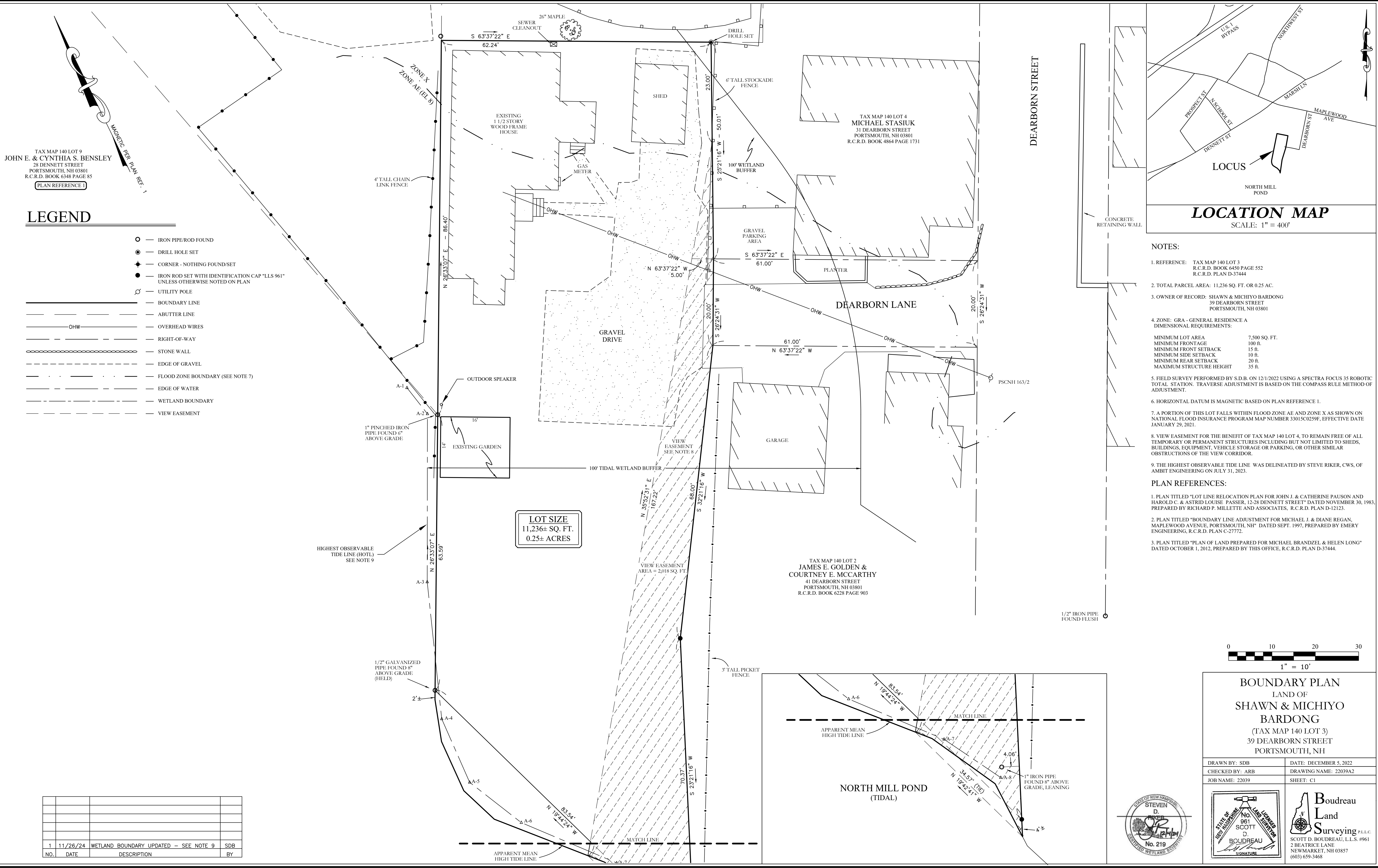

TAX MAP 140 LOT 9
 JOHN E. & CYNTHIA S. BENSLEY
 28 DENNETT STREET
 PORTSMOUTH, NH 03801
 R.C.R.D. BOOK 6348 PAGE 85
 (PLAN REFERENCE 1)

LEGEND

- — IRON PIPE/ROD FOUND
- — DRILL HOLE SET
- ◆ — CORNER - NOTHING FOUND/SET
- — IRON ROD SET WITH IDENTIFICATION CAP "LLS 961" UNLESS OTHERWISE NOTED ON PLAN
- — UTILITY POLE
- — BOUNDARY LINE
- — ABUTTER LINE
- — OHW — OVERHEAD WIRES
- — RIGHT-OF-WAY
- — STONE WALL
- — EDGE OF GRAVEL
- — FLOOD ZONE BOUNDARY (SEE NOTE 7)
- — EDGE OF WATER
- — WETLAND BOUNDARY
- — VIEW EASEMENT

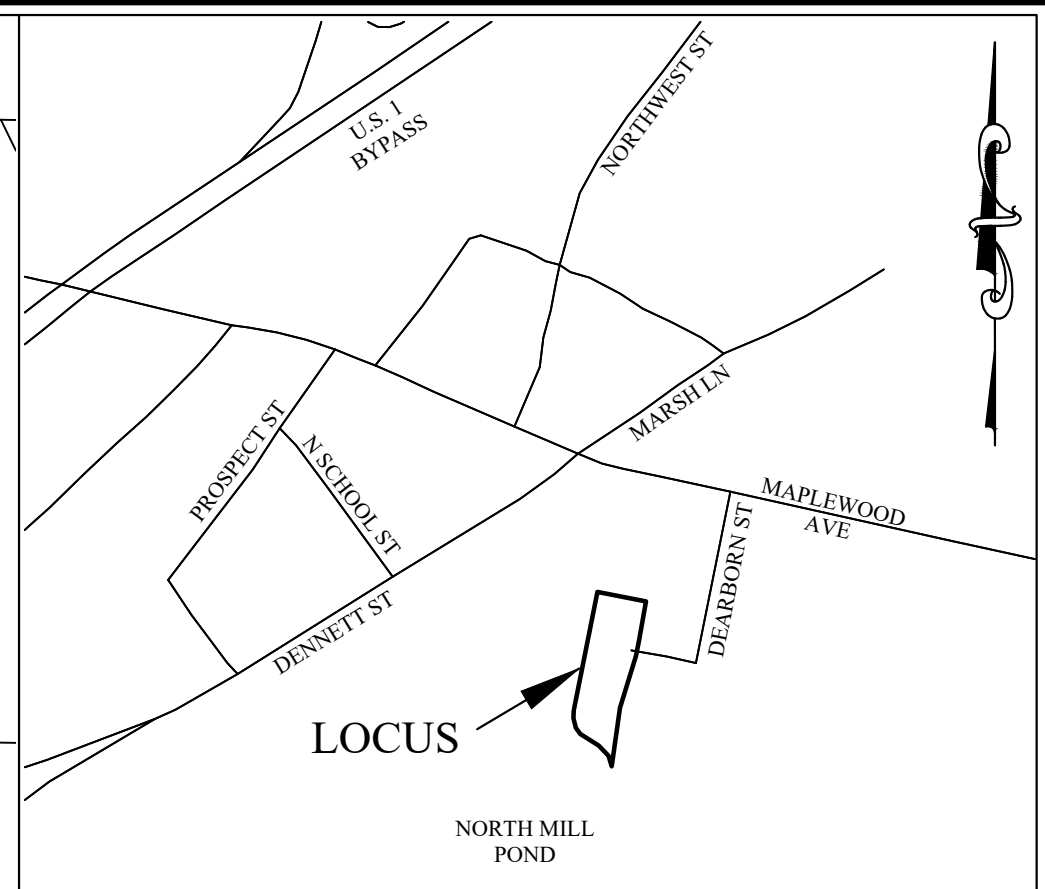

LOCATION MAP
 SCALE: 1" = 400'

- NOTES:**
- REFERENCE: TAX MAP 140 LOT 3 R.C.R.D. BOOK 6450 PAGE 552 R.C.R.D. PLAN D-37444
 - TOTAL PARCEL AREA: 11,236 SQ. FT. OR 0.25 AC.
 - OWNER OF RECORD: SHAWN & MICHIO BARDONG 39 DEARBORN STREET PORTSMOUTH, NH 03801
 - ZONE: GRA - GENERAL RESIDENCE A DIMENSIONAL REQUIREMENTS:
 MINIMUM LOT AREA 7,500 SQ. FT.
 MINIMUM FRONTAGE 100 ft.
 MINIMUM FRONT SETBACK 15 ft.
 MINIMUM SIDE SETBACK 10 ft.
 MINIMUM REAR SETBACK 20 ft.
 MAXIMUM STRUCTURE HEIGHT 35 ft.
 - FIELD SURVEY PERFORMED BY S.D.B. ON 12/1/2022 USING A SPECTRA FOCUS 35 ROBOTIC TOTAL STATION. TRAVERSE ADJUSTMENT IS BASED ON THE COMPASS RULE METHOD OF ADJUSTMENT.
 - HORIZONTAL DATUM IS MAGNETIC BASED ON PLAN REFERENCE 1.
 - A PORTION OF THIS LOT FALLS WITHIN FLOOD ZONE AE AND ZONE X AS SHOWN ON NATIONAL FLOOD INSURANCE PROGRAM MAP NUMBER 33015C0259F, EFFECTIVE DATE JANUARY 29, 2021.
 - VIEW EASEMENT FOR THE BENEFIT OF TAX MAP 140 LOT 4, TO REMAIN FREE OF ALL TEMPORARY OR PERMANENT STRUCTURES INCLUDING BUT NOT LIMITED TO SHEDS, BUILDINGS, EQUIPMENT, VEHICLE STORAGE OR PARKING, OR OTHER SIMILAR OBSTRUCTIONS OF THE VIEW CORRIDOR.
 - THE HIGHEST OBSERVABLE TIDE LINE WAS DELINEATED BY STEVE RIKER, CWS, OF AMBIT ENGINEERING ON JULY 31, 2023.
- PLAN REFERENCES:**
- PLAN TITLED "LOT LINE RELOCATION PLAN FOR JOHN J. & CATHERINE PAUSON AND HAROLD C. & ASTRID LOUISE PASSER, 12-28 DENNETT STREET" DATED NOVEMBER 30, 1983, PREPARED BY RICHARD P. MILLETTE AND ASSOCIATES, R.C.R.D. PLAN D-12123.
 - PLAN TITLED "BOUNDARY LINE ADJUSTMENT FOR MICHAEL J. & DIANE REGAN, MAPLEWOOD AVENUE, PORTSMOUTH, NH" DATED SEPT. 1997, PREPARED BY EMERY ENGINEERING, R.C.R.D. PLAN C-27772.
 - PLAN TITLED "PLAN OF LAND PREPARED FOR MICHAEL BRANDZEL & HELEN LONG" DATED OCTOBER 1, 2012, PREPARED BY THIS OFFICE, R.C.R.D. PLAN D-37444.

LOT SIZE
 11,236± SQ. FT.
 0.25± ACRES

TAX MAP 140 LOT 2
 JAMES E. GOLDEN & COURTNEY E. MCCARTHY
 41 DEARBORN STREET
 PORTSMOUTH, NH 03801
 R.C.R.D. BOOK 6228 PAGE 903

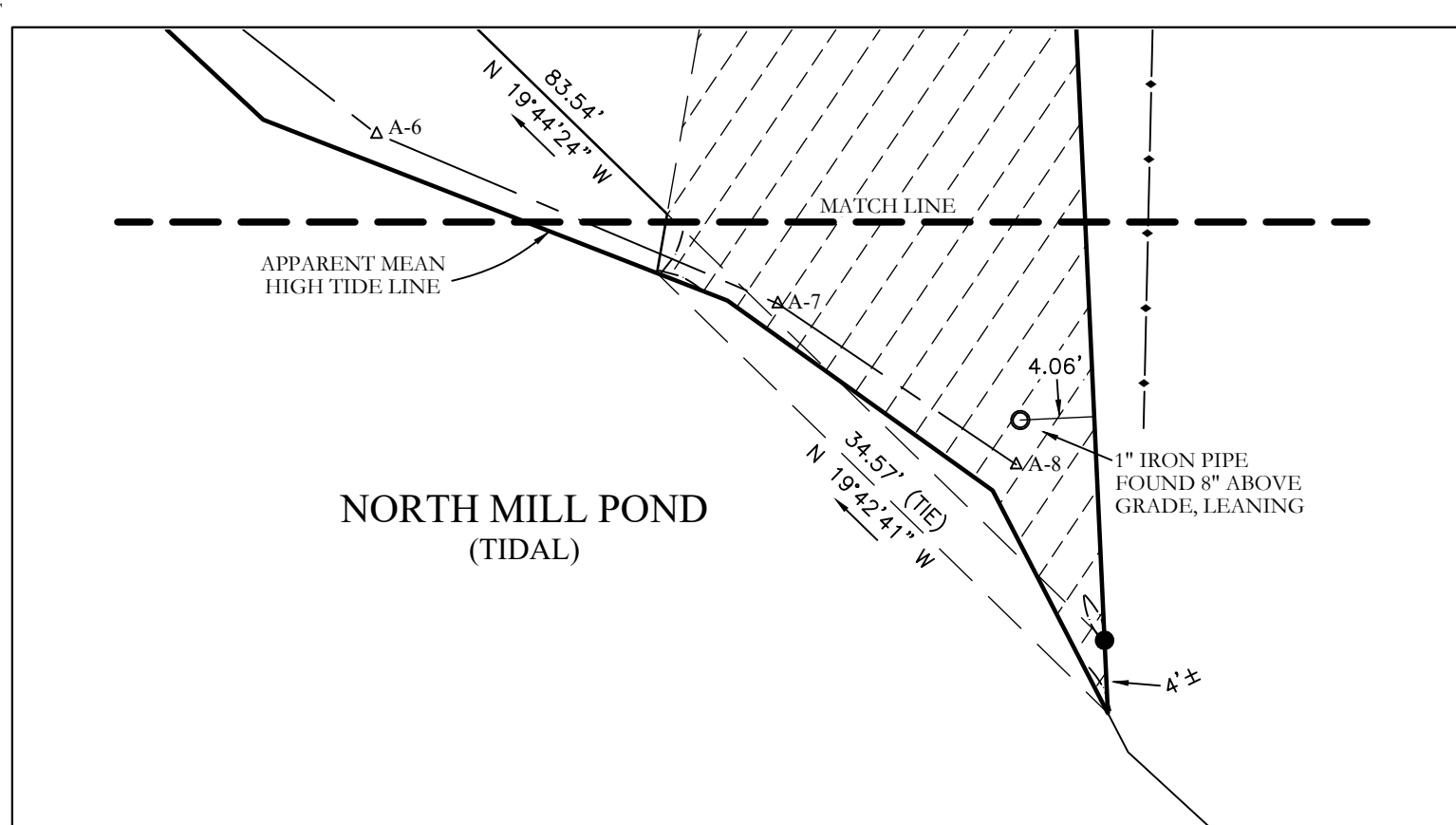
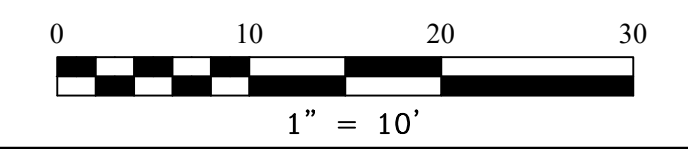

BOUNDARY PLAN
 LAND OF
 SHAWN & MICHIO BARDONG
 (TAX MAP 140 LOT 3)
 39 DEARBORN STREET
 PORTSMOUTH, NH

DRAWN BY: SDB DATE: DECEMBER 5, 2022
 CHECKED BY: ARB DRAWING NAME: 22039A2
 JOB NAME: 22039 SHEET: C1

Boudreau Land Surveying P.L.L.C.
 SCOTT D. BOUDREAU, L.L.S. #961
 2 BEATRICE LANE
 NEWMARKET, NH 03857
 (603) 659-3468

NO.	DATE	DESCRIPTION	BY
1	11/26/24	WETLAND BOUNDARY UPDATED - SEE NOTE 9	SDB